

REV	ECN NO.	LOCAS.	DESCRIPTION	DATE	DESIGN
A			NEW DRAWING		

性能:

额定电流: 0.5A
 额定电压: 50V
 耐电压: 500V
 接触电阻: 30mΩ
 绝缘电阻: 800MΩ
 工作温度: -20℃~+85℃

塑件(材质): LCP BLACK, UL94V-0
 插簧(材质): 磷青铜, 镀锡/镀金

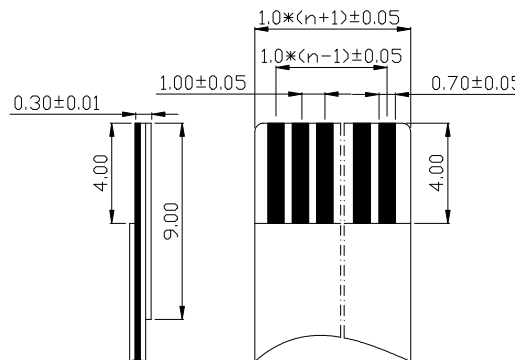
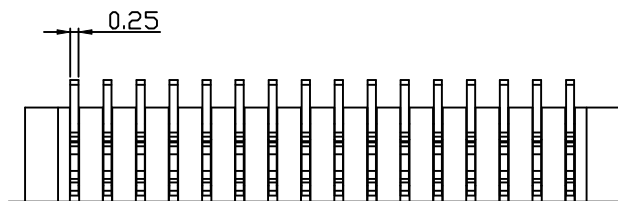
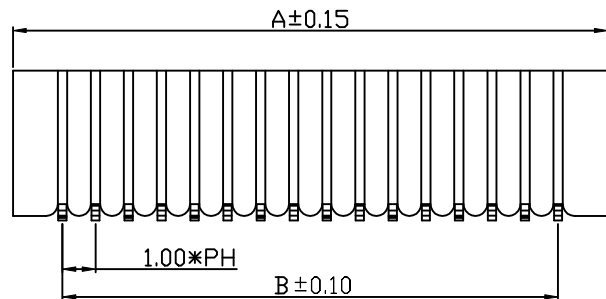
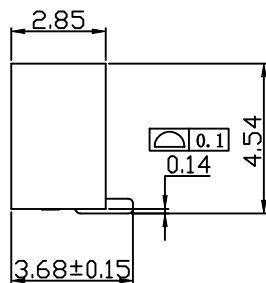
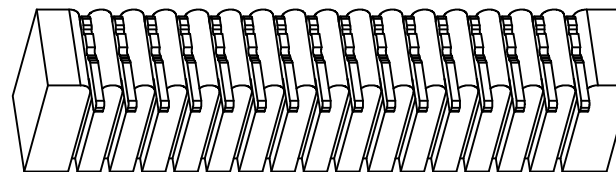
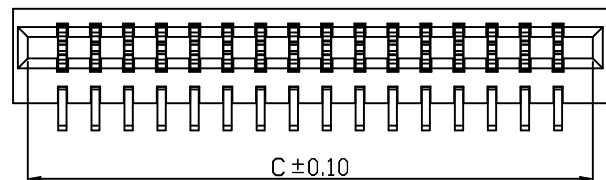

适用扁平电缆

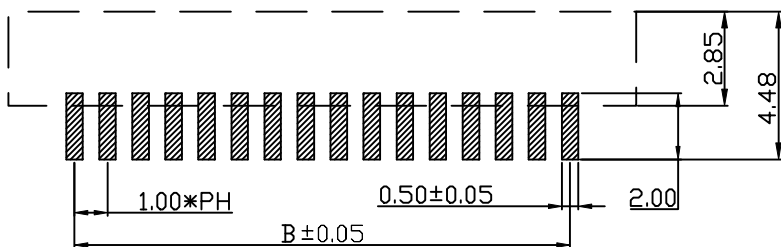

孔位	A	B	C
4	6.00	3.00	5.10
5	7.00	4.00	6.10
6	8.00	5.00	7.10
7	9.00	6.00	8.10
8	10.00	7.00	9.10
9	11.00	8.00	10.10
10	12.00	9.00	11.10
11	13.00	10.00	12.10
12	14.00	11.00	13.10
13	15.00	12.00	14.10
14	16.00	13.00	15.10
15	17.00	14.00	16.10
16	18.00	15.00	17.10
17	19.00	16.00	18.10
18	20.00	17.00	19.10
19	21.00	18.00	20.10
20	22.00	19.00	21.10
21	23.00	20.00	22.10
22	24.00	21.00	23.10
23	25.00	22.00	24.10
24	26.00	23.00	25.10
25	27.00	24.00	26.10
26	28.00	25.00	27.10
27	29.00	26.00	28.10
28	30.00	27.00	29.10
29	31.00	28.00	30.10
30	32.00	29.00	31.10
31	33.00	30.00	32.10
32	34.00	31.00	33.10
33	35.00	32.00	34.10
34	36.00	33.00	35.10
35	37.00	34.00	36.10

PCB LAYOUT

DESIGN:	Xiping Huang		QWYCONN® 深圳市启崮源电子有限公司	
CHECK:	Ke Tian		SHENZHEN QIWEIYUAN ELECTRONIC CO., LTD.	
APPROVED:	Youquan Xu		TITLE: 1.0mm FPC (双面接) 单边立贴短脚	
DIM	TOL	DIM	TOL	PART NO. 1.0-C-nPB
X.	±0.25	X°	±3.0°	REV. A
X.X	±0.20	X.X°		SCALE: N/A
X.XX	±0.15	X.XX°		UNIT: mm
X.XXX		X.XXX°		SHEET: 1/1