

REV.	ECN NO.	LOCAS.	DESCRIPTION	DATE	DESIGN
A			NEW DRAWING	22.12.01	Jenply

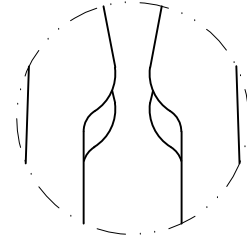

DETAIL A
SCALE 4:1

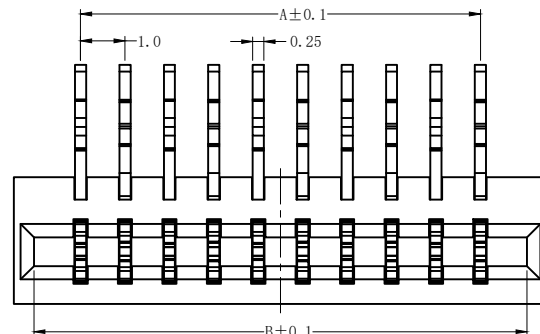
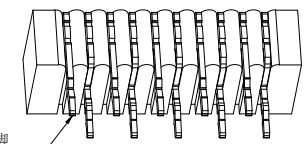

正脚基准脚
positive foot

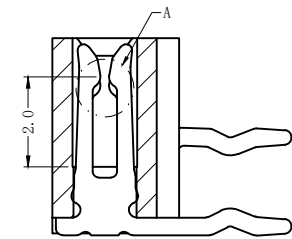
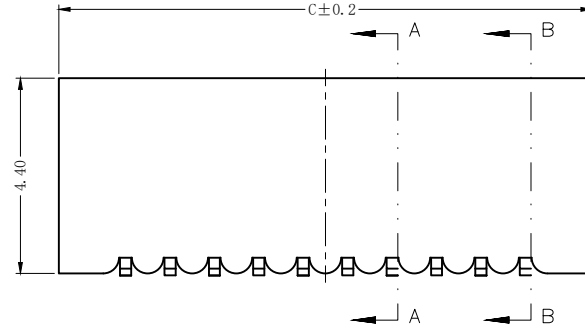
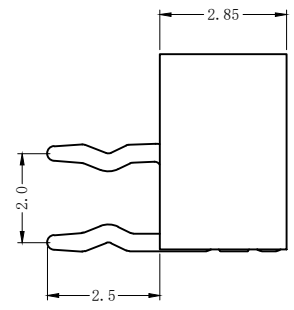

SECTION A-A

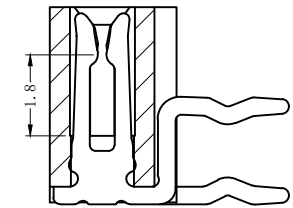

SECTION B-B

孔位	A	B	C
4	3.00	5.10	6.00
5	4.00	6.10	7.00
6	5.00	7.10	8.00
7	6.00	8.10	9.00
8	7.00	9.10	10.00
9	8.00	10.10	11.00
10	9.00	11.10	12.00
11	10.00	12.10	13.00
12	11.00	13.10	14.00
13	12.00	14.10	15.00
14	13.00	15.10	16.00
15	14.00	16.10	17.00
16	15.00	17.10	18.00
17	16.00	18.10	19.00
18	17.00	19.10	20.00
19	18.00	20.10	21.00
20	19.00	21.10	22.00
21	20.00	22.10	23.00
22	21.00	23.10	24.00
23	22.00	24.10	25.00
24	23.00	25.10	26.00
25	24.00	26.10	27.00
26	25.00	27.10	28.00
27	26.00	28.10	29.00
28	27.00	29.10	30.00
29	28.00	30.10	31.00
30	29.00	31.10	32.00
31	30.00	32.10	33.00
32	31.00	33.10	34.00
33	32.00	34.10	35.00
34	33.00	35.10	36.00

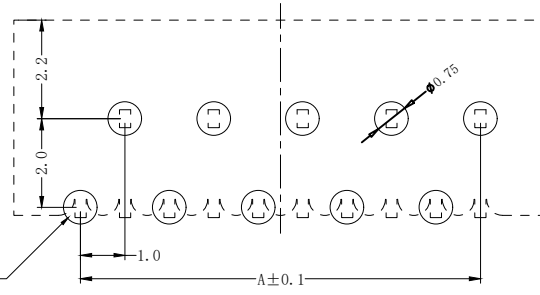

定义正脚基准脚
Define the positive
foot reference foot

PC BOARD LAYOUT

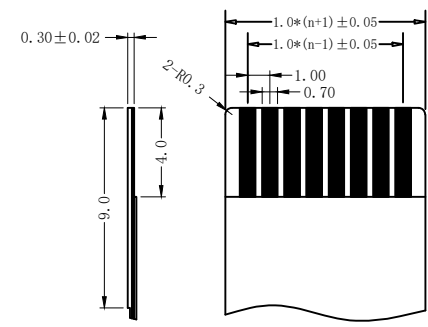

PROPER CABLE (SCALE 2:1)

技术要求 (Technical Index):

1. 材质与表面处理 (Material And Finish):
基座 (Housing): LCP UL94V-0 Nature Or Black;
端子 (Terminal): Phosphor Copper Au/Sn Plated;
焊片 (Solder): Copper Alloy Au/Sn Plated;
2. 工作温度 (Temperature range): -20° C ~ +85° C.
3. 额定电压 (Rated voltage): 50V, AC/DC.
4. 额定电流: 0.5A, AC/DC.
5. 接触电阻 (Contact resistance): ≤30mΩ.
6. 绝缘电阻 (Insulation resistance): ≥800MΩ.
7. 耐电压 (Withstanding Voltage): 500V AC/minute.

DESIGN:	Jenply			深圳市启崴源电子有限公司 SHENZHEN QIWEIYUAN ELECTRONIC CO., LTD.
CHECK:	Ke Tian			
APPROVED:	Youquan Xu			TITLE: 1.0mm 双面接弯插正脚
DIM	TOL	DIM	TOL	PART NO. 1.0-B-nPW-***
X.	±0.25	X°	±3.0°	REV. A SCALE: N/A UNIT: mm SHEET: 1/1
X.X	±0.20	X.X°		
X.XX	±0.15	X.XX°		
X.XXX		X.XXX°		