

| REV. | ECN NO. | LOCAS. | DESCRIPTION | DATE | DESIGN |
|------|---------|--------|-------------|----------|--------|
| A | | | NEW DRAWING | 22.12.01 | Jenply |

| 孔位 | A | B | C |
|----|-------|-------|-------|
| 4 | 3.00 | 5.10 | 6.00 |
| 5 | 4.00 | 6.10 | 7.00 |
| 6 | 5.00 | 7.10 | 8.00 |
| 7 | 6.00 | 8.10 | 9.00 |
| 8 | 7.00 | 9.10 | 10.00 |
| 9 | 8.00 | 10.10 | 11.00 |
| 10 | 9.00 | 11.10 | 12.00 |
| 11 | 10.00 | 12.10 | 13.00 |
| 12 | 11.00 | 13.10 | 14.00 |
| 13 | 12.00 | 14.10 | 15.00 |
| 14 | 13.00 | 15.10 | 16.00 |
| 15 | 14.00 | 16.10 | 17.00 |
| 16 | 15.00 | 17.10 | 18.00 |
| 17 | 16.00 | 18.10 | 19.00 |
| 18 | 17.00 | 19.10 | 20.00 |
| 19 | 18.00 | 20.10 | 21.00 |
| 20 | 19.00 | 21.10 | 22.00 |
| 21 | 20.00 | 22.10 | 23.00 |
| 22 | 21.00 | 23.10 | 24.00 |
| 23 | 22.00 | 24.10 | 25.00 |
| 24 | 23.00 | 25.10 | 26.00 |
| 25 | 24.00 | 26.10 | 27.00 |
| 26 | 25.00 | 27.10 | 28.00 |
| 27 | 26.00 | 28.10 | 29.00 |
| 28 | 27.00 | 29.10 | 30.00 |
| 29 | 28.00 | 30.10 | 31.00 |
| 30 | 29.00 | 31.10 | 32.00 |
| 31 | 30.00 | 32.10 | 33.00 |
| 32 | 31.00 | 33.10 | 34.00 |
| 33 | 32.00 | 34.10 | 35.00 |
| 34 | 33.00 | 35.10 | 36.00 |

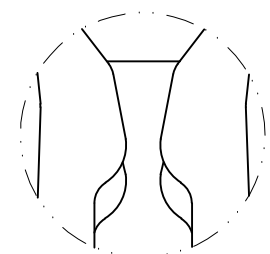

DETAIL A
SCALE 4:1

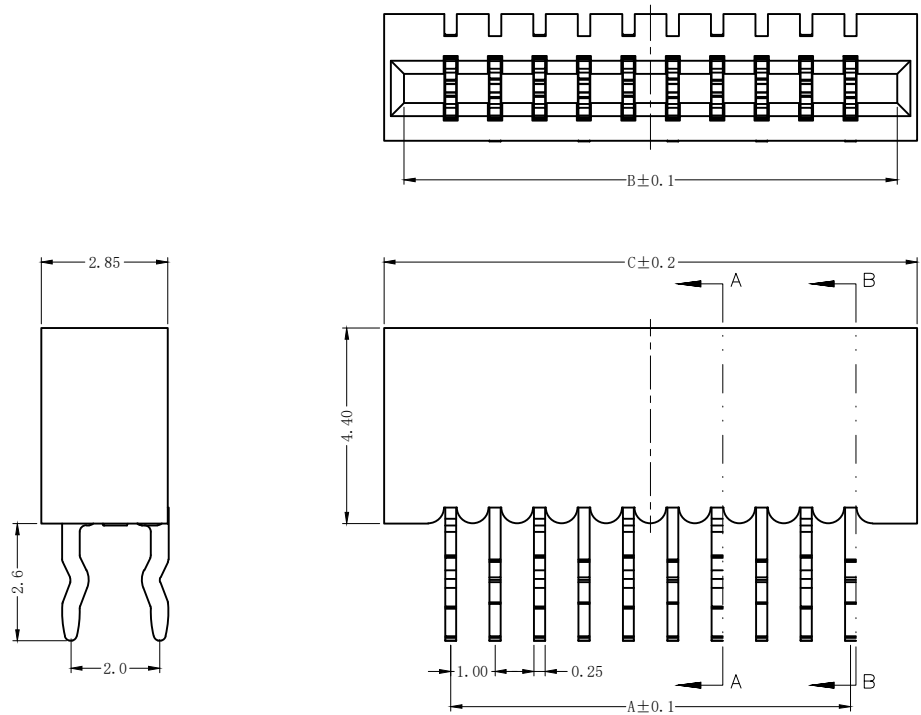
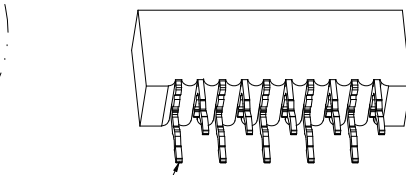

反脚基准脚
opposite foot

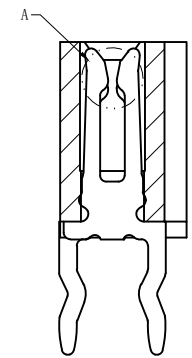

SECTION A-A

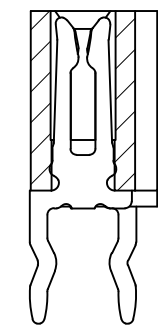

SECTION B-B

定义反脚基准脚
Define the opposite
foot reference foot

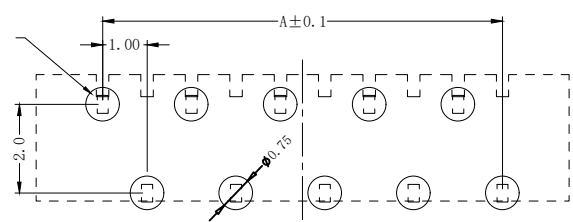

PC BOARD LAYOUT

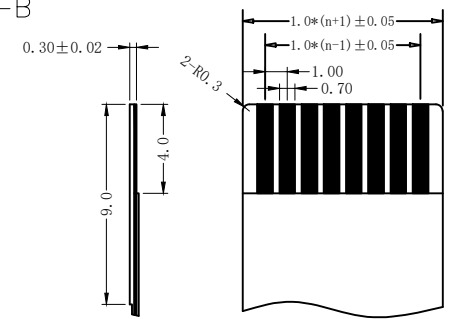

PROPER CABLE (SCALE 2:1)

技术要求 (Technical Index):

1. 材质与表面处理 (Material And Finish):
基座 (Housing): LCP UL94V-0 Nature Or Black;
端子 (Terminal): Phosphor Copper Au/Sn Plated;
焊片 (Solder): Copper Alloy Au/Sn Plated;
2. 工作温度 (Temperature range): -20° C ~ +85° C.
3. 额定电压 (Rated voltage): 50V, AC/DC.
4. 额定电流: 0.5A, AC/DC.
5. 接触电阻 (Contact resistance): ≤30mΩ.
6. 绝缘电阻 (Insulation resistance): ≥800MΩ.
7. 耐电压 (Withstanding Voltage): 500V AC/minute.

| | | | | |
|-----------|------------|--------|-------|---|
| DESIGN: | Jenply | | | 深圳市启崴源电子有限公司 SHENZHEN QIWEIYUAN ELECTRONIC CO., LTD. |
| CHECK: | Ke Tian | | | |
| APPROVED: | Youquan Xu | | | TITLE: 1.0mm 双面接直插反脚 |
| DIM | TOL | DIM | TOL | PART NO. 1.0-B-nPF-*** |
| X. | ±0.25 | X° | ±3.0° | REV. A |
| X.X | ±0.20 | X.X° | | SCALE: N/A |
| X.XX | ±0.15 | X.XX° | | UNIT: mm |
| X.XXX | | X.XXX° | | SHEET: 1/1 |