

REV.	ECN NO.	LOCAS.	DESCRIPTION	DATE	DESIGN
A			NEW DRAWING	22.12.01	Jenply

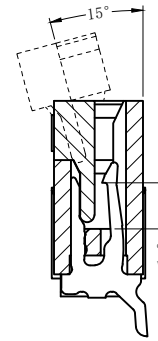

SECTION B-B

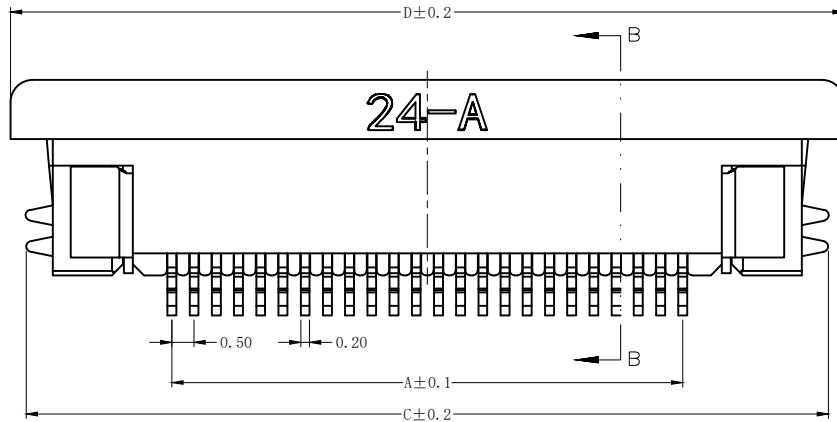
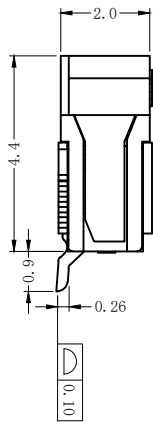
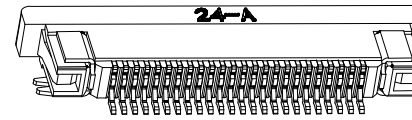
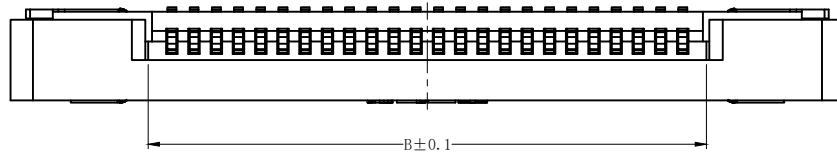
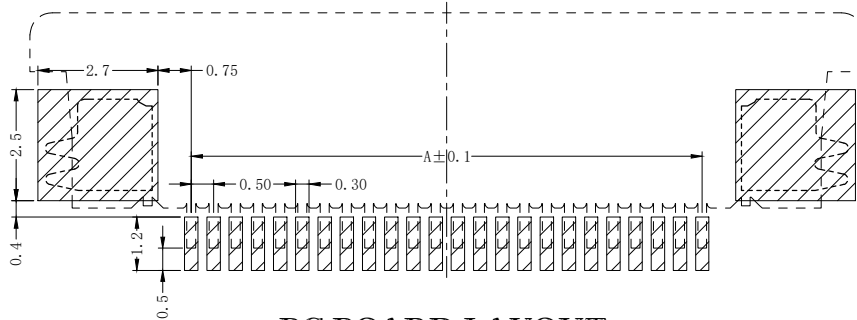

PC BOARD LAYOUT

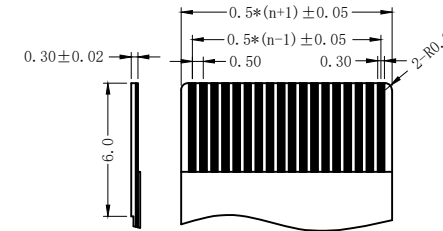

PROPER CABLE (SCALE 2:1)

孔位	A	B	C	D
4	1.50	2.60	8.00	8.70
5	2.00	3.10	8.50	9.20
6	2.50	3.60	9.00	9.70
7	3.00	4.10	9.50	10.20
8	3.50	4.60	10.00	10.70
9	4.00	5.10	10.50	11.20
10	4.50	5.60	11.00	11.70
11	5.00	6.10	11.50	12.20
12	5.50	6.60	12.00	12.70
13	6.00	7.10	12.50	13.20
14	6.50	7.60	13.00	13.70
15	7.00	8.10	13.50	14.20
16	7.50	8.60	14.00	14.70
17	8.00	9.10	14.50	15.20
18	8.50	9.60	15.00	15.70
19	9.00	10.10	15.50	16.20
20	9.50	10.60	16.00	16.70
21	10.00	11.10	16.50	17.20
22	10.50	11.60	17.00	17.70
23	11.00	12.10	17.50	18.20
24	11.50	12.60	18.00	18.70
25	12.00	13.10	18.50	19.20
26	12.50	13.60	19.00	19.70
27	13.00	14.10	19.50	20.20
28	13.50	14.60	20.00	20.70
29	14.00	15.10	20.50	21.20
30	14.50	15.60	21.00	21.70
31	15.00	16.10	21.50	22.20
32	15.50	16.60	22.00	22.70
33	16.00	17.10	22.50	23.20
34	16.50	17.60	23.00	23.70
35	17.00	18.10	23.50	24.20
36	17.50	18.60	24.00	24.70
37	18.00	19.10	24.50	25.20
38	18.50	19.60	25.00	25.70
39	19.00	20.10	25.50	26.20
40	19.50	20.60	26.00	26.70
41	20.00	21.10	26.50	27.20
42	20.50	21.60	27.00	27.70
43	21.00	22.10	27.50	28.20
44	21.50	22.60	28.00	28.70
45	22.00	23.10	28.50	29.20
46	22.50	23.60	29.00	29.70
47	23.00	24.10	29.50	30.20
48	23.50	24.60	30.00	30.70
49	24.00	25.10	30.50	31.20
50	24.50	25.60	31.00	31.70
51	25.00	26.10	31.50	32.20
52	25.50	26.60	32.00	32.70
53	26.00	27.10	32.50	33.20
54	26.50	27.60	33.00	33.70
55	27.00	28.10	33.50	34.20
56	27.50	28.60	34.00	34.70
57	28.00	29.10	34.50	35.20
58	28.50	29.60	35.00	35.70
59	29.00	30.10	35.50	36.20
60	29.50	30.60	36.00	36.70

技术要求 (Technical Index):

1. 材质与表面处理 (Material And Finish):
基座 (Housing) and 盖子 (Cover): LCP UL94V-0 Nature Or Black;
端子 (Terminal): Phosphor Copper Au/Sn Plated;
焊片 (Solder): Copper Alloy Au/Sn Plated;
2. 工作温度 (Temperature range): -25° C ~ +85° C.
3. 额定电压 (Rated voltage): 50V, AC/DC.
4. 额定电流: 0.4A, AC/DC.
5. 接触电阻 (Contact resistance): ≤ 20mΩ.
6. 绝缘电阻 (Insulation resistance): ≥ 500MΩ.
7. 耐电压 (Withstanding Voltage): 200V AC/minute.

DESIGN:	Jenply		QWYCONN® 深圳市启崴源电子有限公司 SHENZHEN QIWEIYUAN ELECTRONIC CO., LTD.	
CHECK:	Ke Tian			
APPROVED:	Youquan Xu		TITLE:	
DIM	TOL	DIM	TOL	0.5mm FPC (B 型) 下接
X.	±0.25	X°	±3.0°	PART NO.
X.X	±0.20	X.X°		0.5K-BX-nPWB-***
X.XX	±0.15	X.XX°		REV. A
X.XXX		X.XXX°		SCALE: N/A
				UNIT: mm
				SHEET: 1/1
				⊕